

Understanding Fiber Polarity



1. What's Polarity?

In any installation, it is important to ensure that the optical transmitter at one end is connected to the optical receiver at the other. This matching of the transmit signal (Tx) to the receive equipment (Rx) at both ends of the fiber optic link is referred to as polarity.

2. Polarity Overview

Two types of fiber links are outlined in the TIA standard: serial duplex signals connections and parallel signals connections. This paper discusses the impact of polarity as it pertains to serial duplex signals and parallel signals.

2.1 Fiber Patch cords

Two types of duplex fiber patch cords are defined in the TIA standard: A-to-A type shown in Figure 1 and A-to-B type shown in Figure 2. Note: A-to-A patch cords are not commonly deployed and should be used only when necessary as part of a polarity method (See ANSI/TIA-568-C.0).

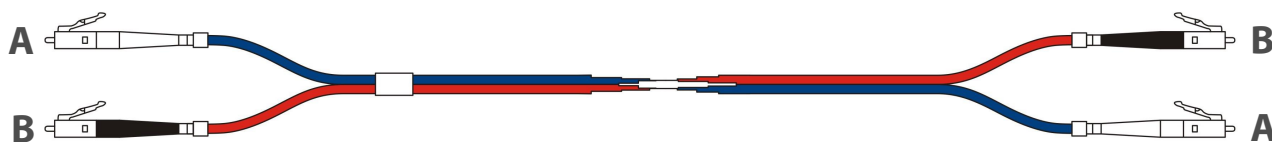

A-to-A Patch Cord

Figure 1

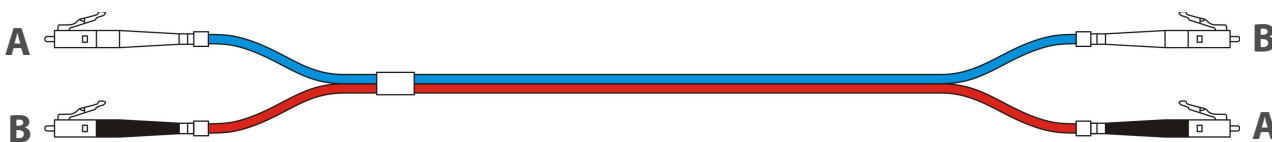

A-to-B Patch Cord

Figure 2

2.2 MTP/MPO Fiber Adapter

2.2.1 Type A adapters

There are two types of array adapters, Type A and Type B. Type A adapters shall mate two array connectors with the connector keys key-up to key-down.

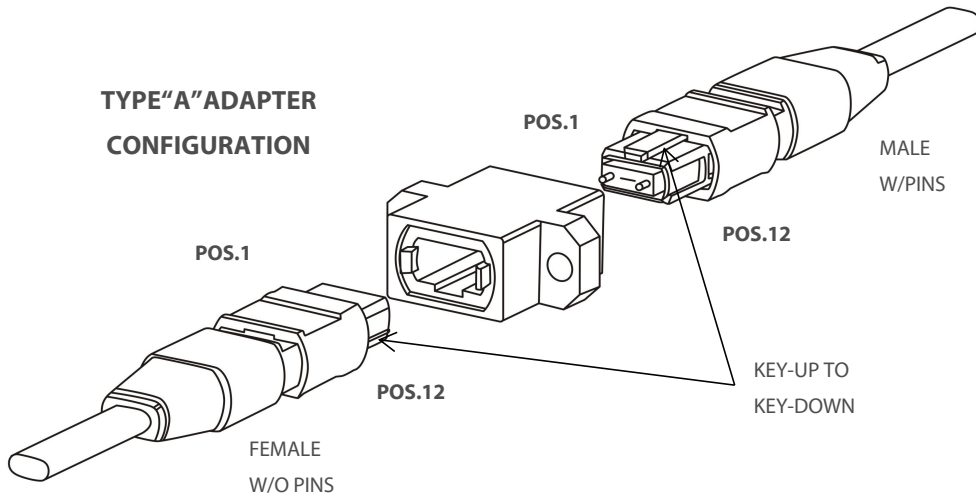

2.2.2 Type B adapters

Type B adapters shall mate two array connectors with the connector keys key-up to key-up (keys aligned).

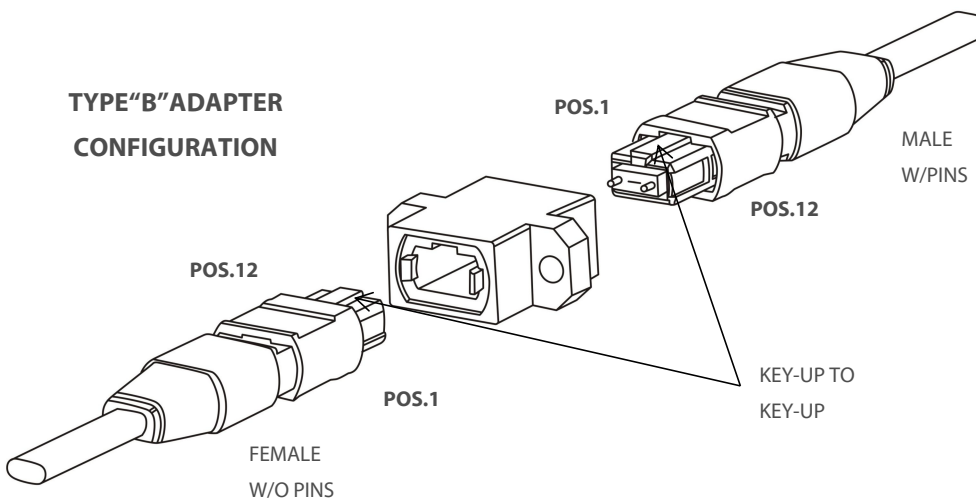

2.3 12-fiber MTP/MPO array patch cord

There are three different 12-fiber MPO/MTP-to-MPO/MTP backbone cables defined in the TIA standard. The three different cables: Type A, B and C are used for the three different connectivity Methods A, B and C respectively.

Type A
"Straight Through"
Key-up to Key-Down
P1 to P1

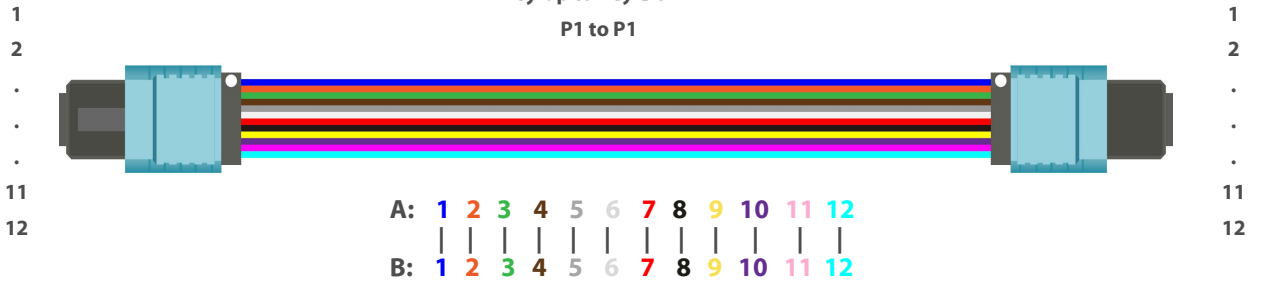

Type B
"Cross Over"
Key-up to Key-up
P1 to P12

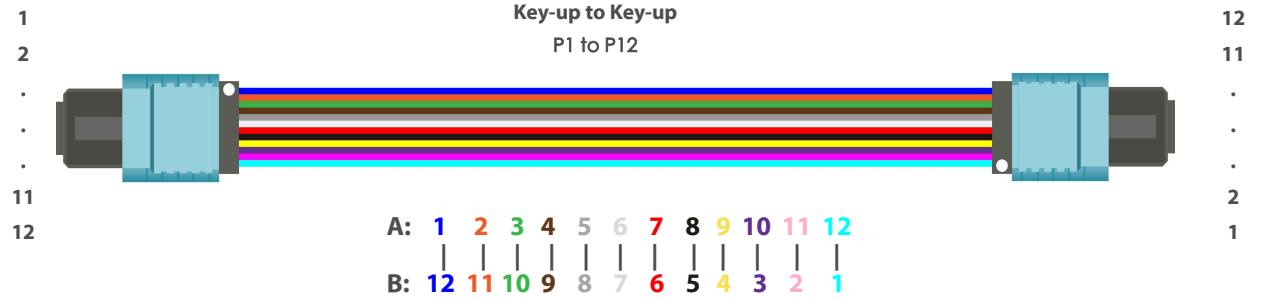

Type C
"Cross Pair"
Key-up to Key-Down
P1 to P2

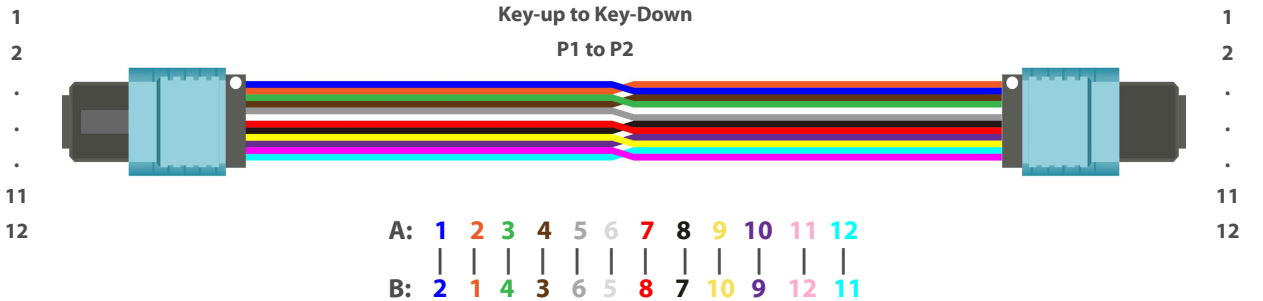

2.4 24-fiber MTP/MPO array patch cord

There are three different 24-fiber MPO/MTP-to-MPO/MTP backbone cables defined in the TIA standard (TIA-568.3-D). The three different cables: Type A, B and C are used for the three different connectivity Methods A, B and C respectively.

Type A
Key-up to Key-Down
P1 to P13



A:	1	2	3	4	5	6	7	8	9	10	11	12
B:	13	14	15	16	17	18	19	20	21	22	23	24
A:	13	14	15	16	17	18	19	20	21	22	23	24
B:	1	2	3	4	5	6	7	8	9	10	11	12

Type B
Key-up to Key-up
P1 to P24

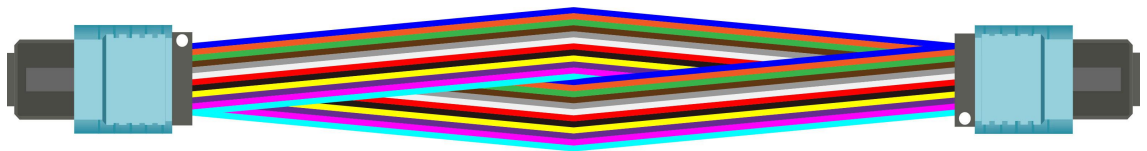

A:	1	2	3	4	5	6	7	8	9	10	11	12
B:	24	23	22	21	20	19	18	17	16	15	14	13
A:	13	14	15	16	17	18	19	20	21	22	23	24
B:	12	11	10	9	8	7	6	5	4	3	2	1

Type C
Key-up to Key-Down
P1 to P14

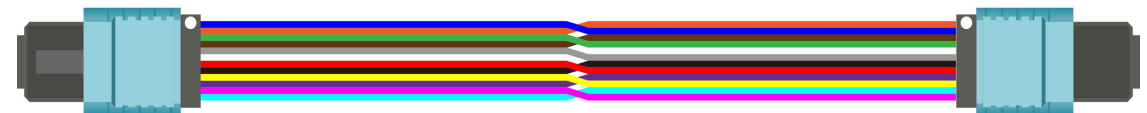

A:	1	2	3	4	5	6	7	8	9	10	11	12
B:	14	13	16	15	18	17	20	19	22	21	24	23
A:	13	14	15	16	17	18	19	20	21	22	23	24
B:	2	1	4	3	6	5	8	7	10	9	12	11

2.5 8-fiber MTP/MPO breakout patch cord

There are two different 8-fiber MPO/MTP breakout cables: Type A and Type B.

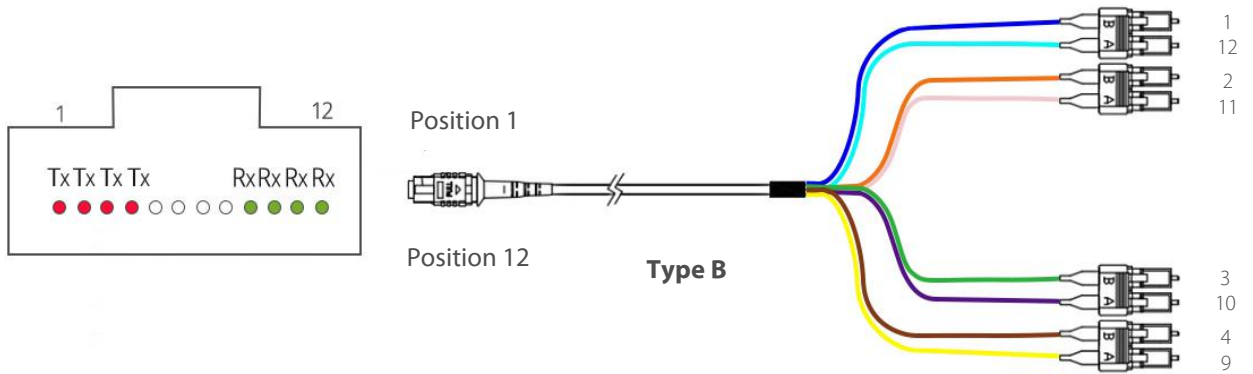
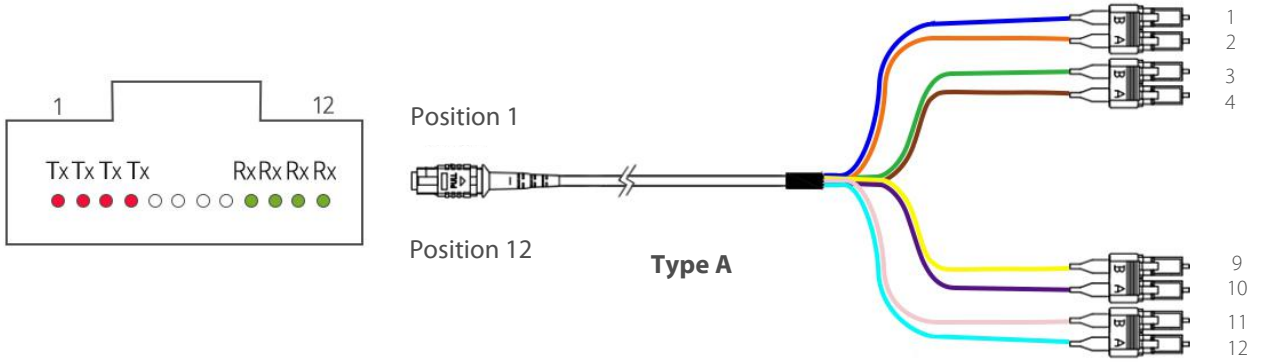

2.6 12-fiber MTP/MPO breakout patch cord

There are two different 12-fiber MTP/MPO breakout cables: Type A and Type B.

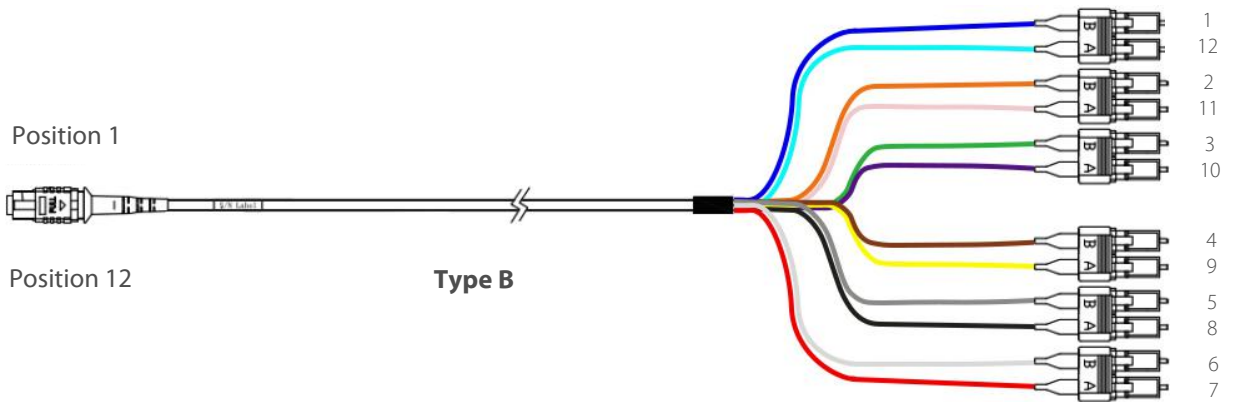
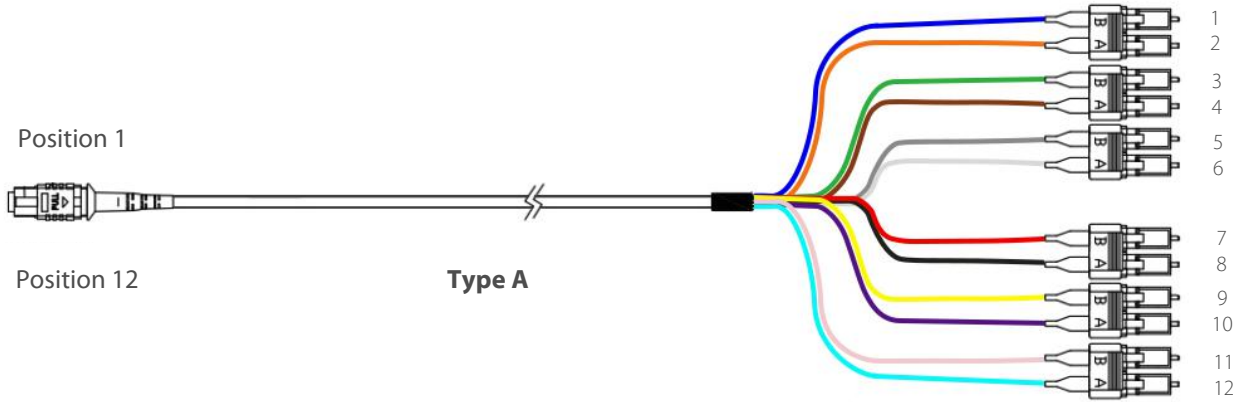

2.7 20-fiber MTP/MPO breakout patch cord

There are three different 20-fiber MTP/MPO breakout cables: Type A, Type B and Type C.

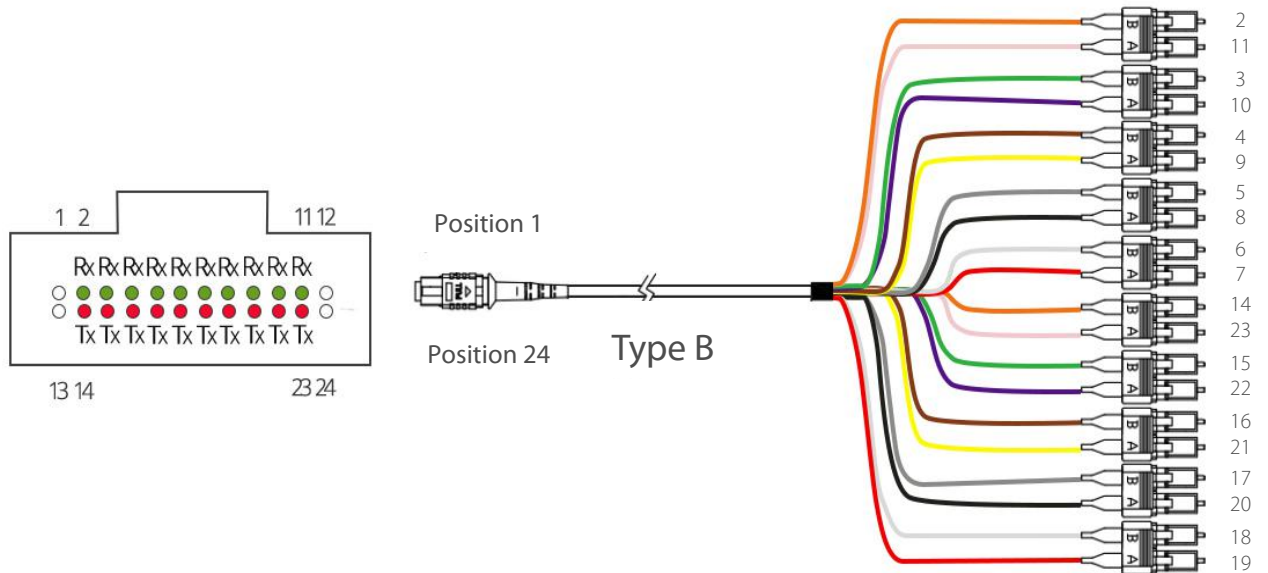
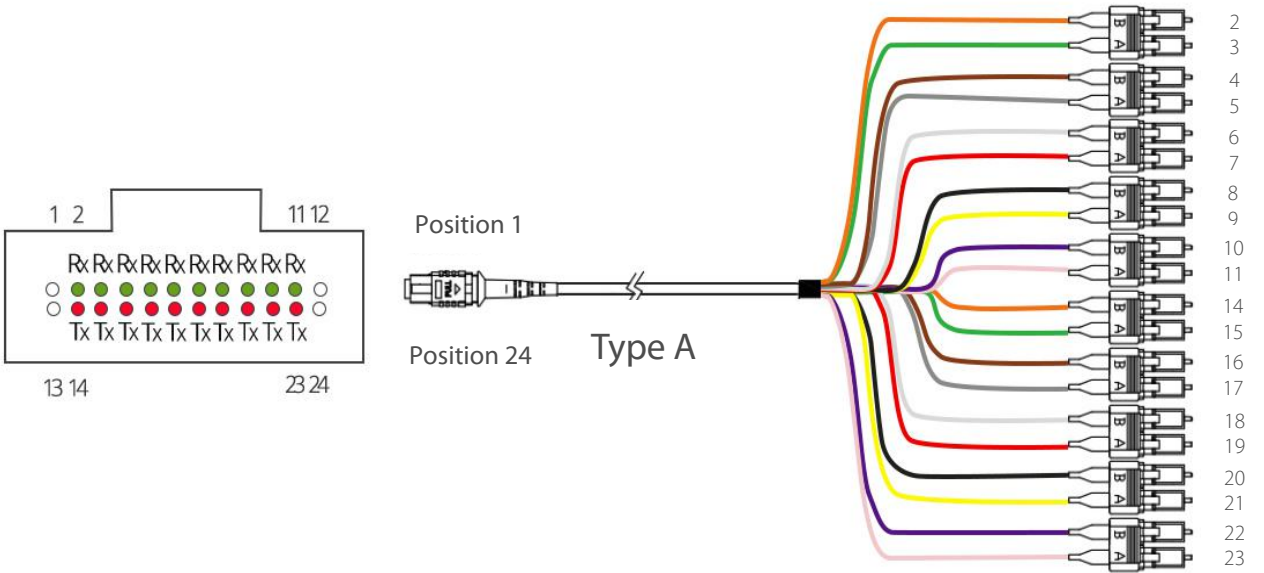

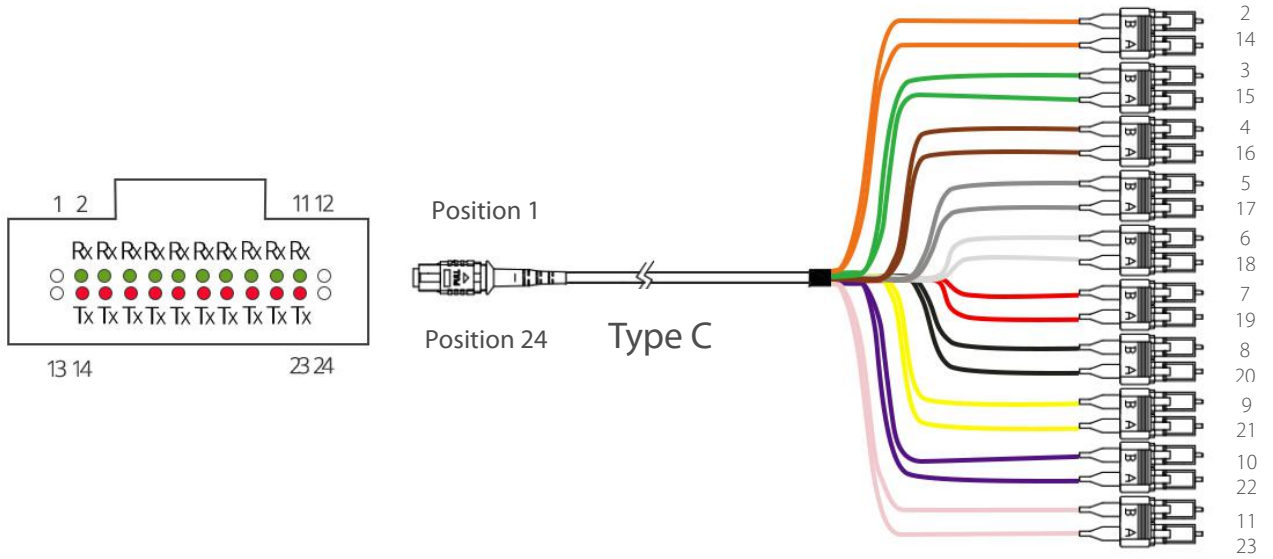

2.8 24-fiber MTP/MPO breakout patch cord

There are three different 24-fiber MTP/MPO breakout cables: Type A, Type B and Type C.

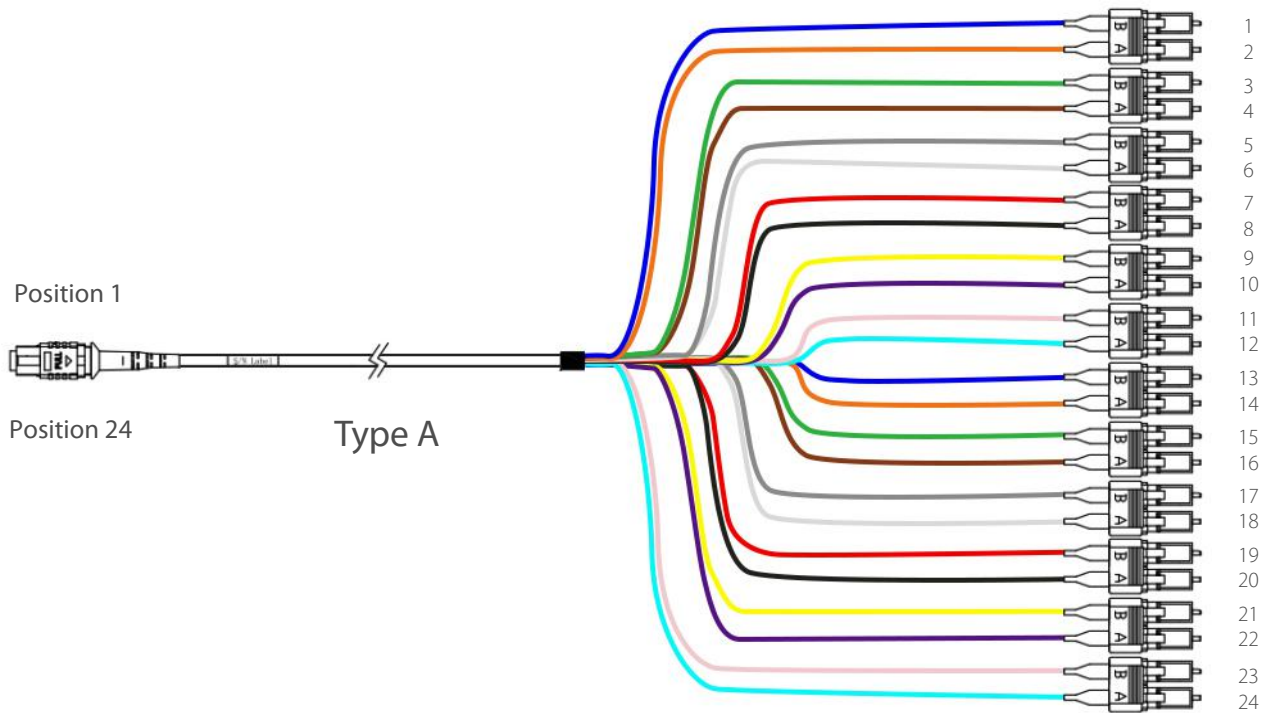

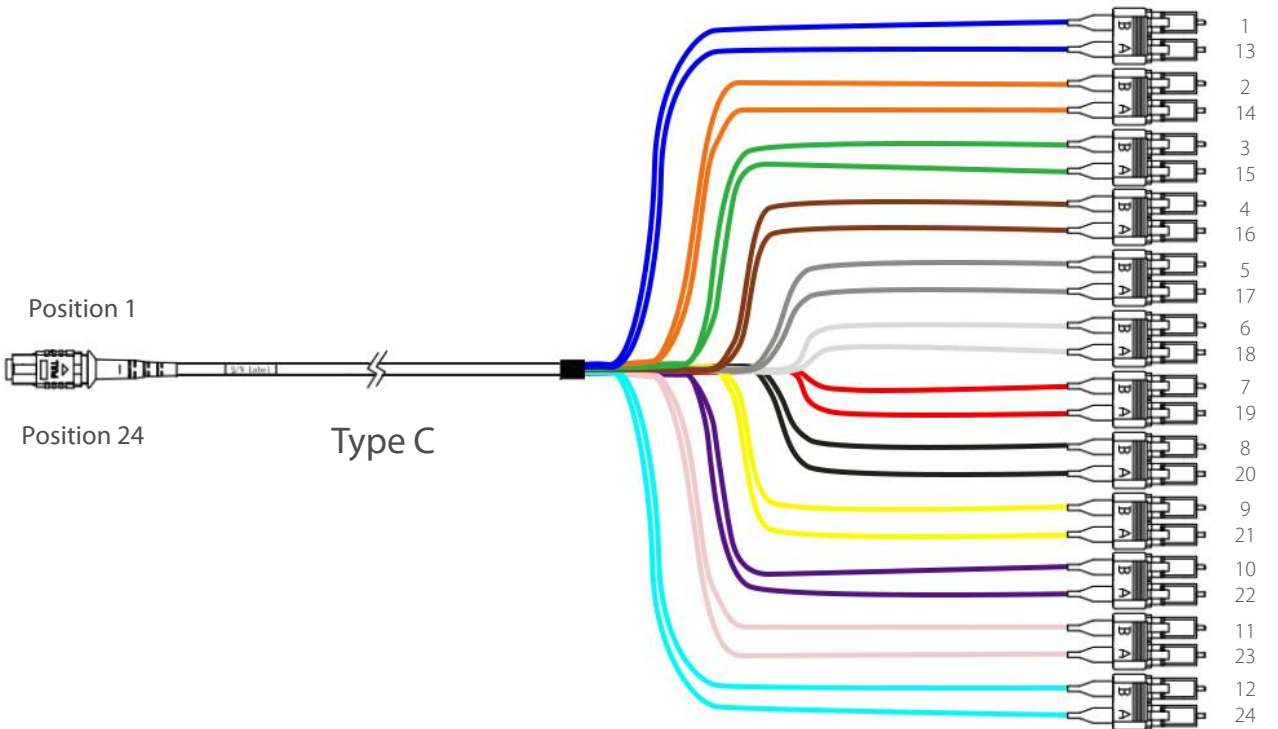
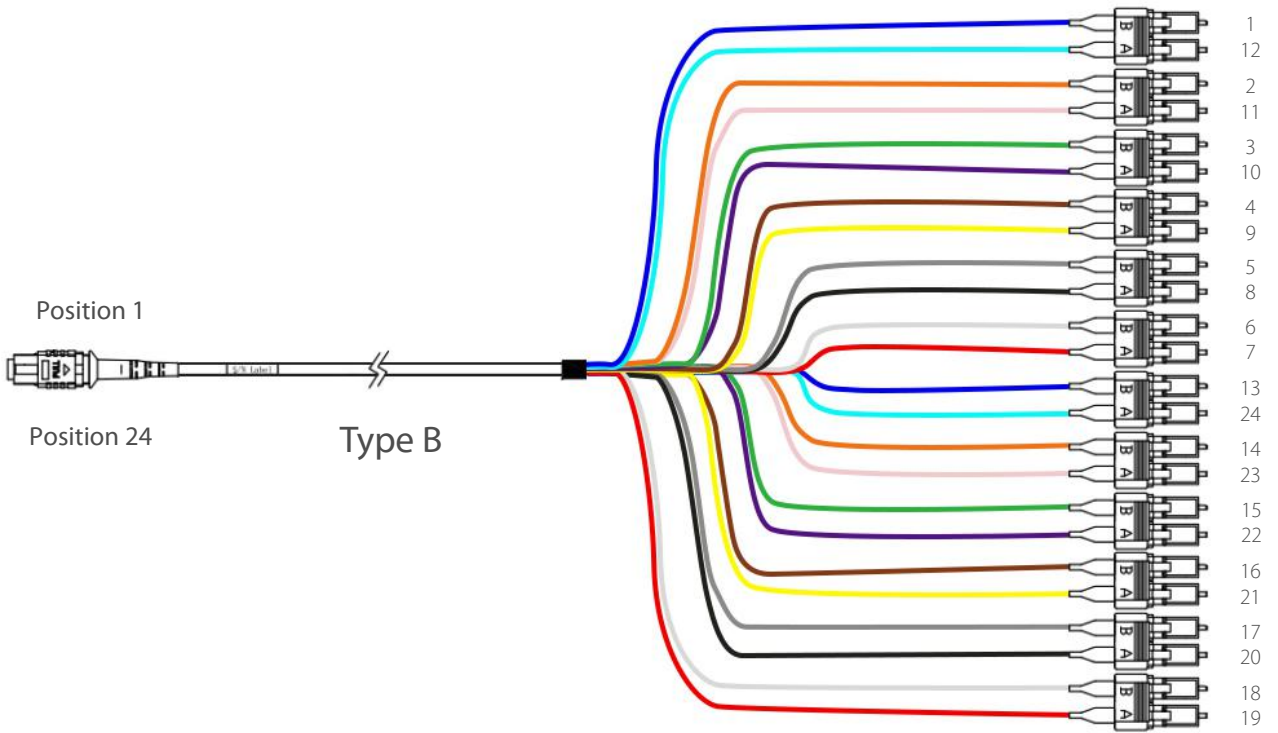

2.9 MTP/MPO cassette modules

2.9.1 Base-8 series

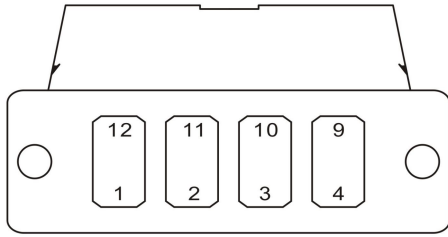

Fiber Sequence

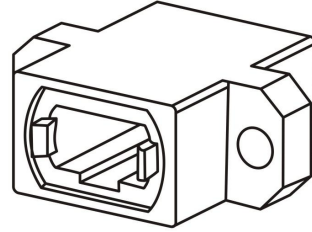

Type A adapter

2.9.2 Base-12 series

There are four different 12/24 Fibers MTP/MPO cassette modules: Type A, AF(Pair Flipped), B1 and B2.

Polarity Type	Inner Fiber Sequence	Adapter
A		Type A Up-to-Down
AF		Type A Up-to-Down
B1		Type B Up-to-Up
B2		Type B Up-to-Up

2.9.3 Base-24 series

There are two different 24 Fibers MTP/MPO cassette modules: Type A, and AF(Pair Flipped).

Polarity Type	Inner Fiber Sequence	Adapter
A		Type A Up-to-Down
AF		Type A Up-to-Down

3. Array polarity systems

All array connectivity methods have the same goal: to create an optical path from the transmit port of one device to the receive port of another device. Different methods to accomplish this goal may be implemented; however these different methods may not be interoperable.

Any connectivity method requires a specific combination of components to maintain polarity. Some of the components may be common to other connectivity methods. The components associated with the three illustrated array polarity methods A, B and C are given in below tables.

Table 1 – Summary of components used for duplex signals

Connectivity method	Array connector cable Type	Array adapter Type	Duplex patch cord Type
A	A	A	One A-to-B & one A-to-A per duplex channel
B	B	B	A-to-B
C	C	A	A-to-B

Table 2 – Summary of components used for parallel signals

Connectivity method	Array connector cable Type	Array adapter Type	Array patch cord type
A	A	A	One Type A & one Type B
B	B	B	Type B

3.1 Connectivity Method A

3.1.1 Connectivity Method A for duplex signals

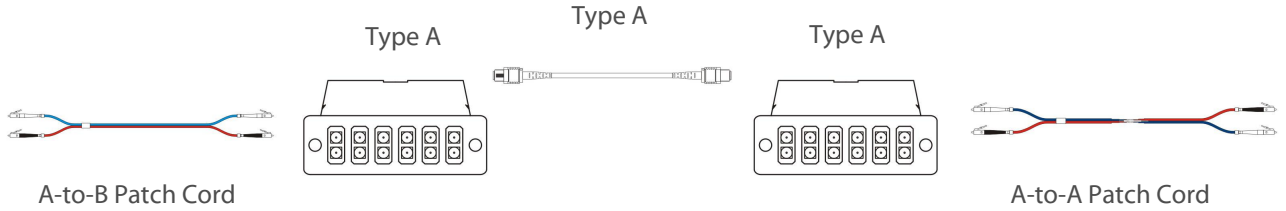

Note: If you don't want an A-to-A patch cord used, a Type AF MTP/MPO cassette is needed, as shown below:

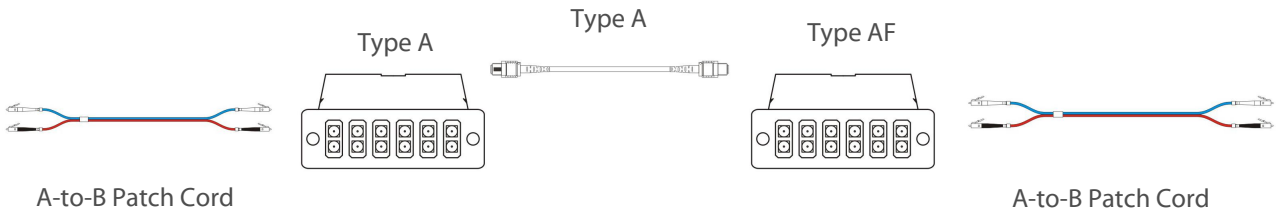

3.1.2 Connectivity Method A for parallel signals



3.2 Connectivity Method B

3.2.1 Connectivity Method B for duplex signals

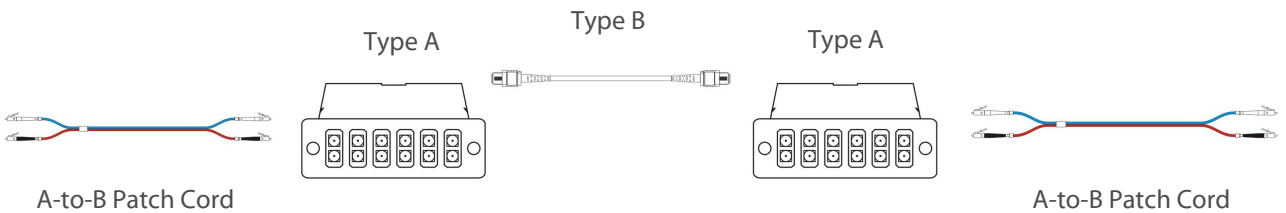

Note: The transmission of the signal is P1 in and P12 out.

4. Polarity systems of 24-Fiber

The 100G-SR10 (100 GbE over multimode) requires a total of 20 fibers, 10 transmit and 10 receive. Position assignment shown below is recommended by IEEE.

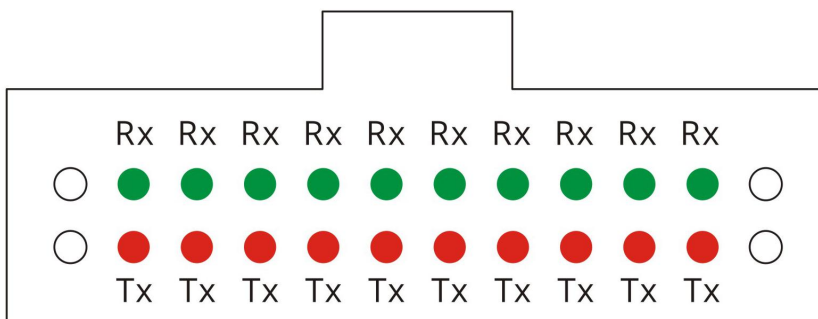

4.1 Connection of Type A 24-Fiber MTP/MPO patch cord

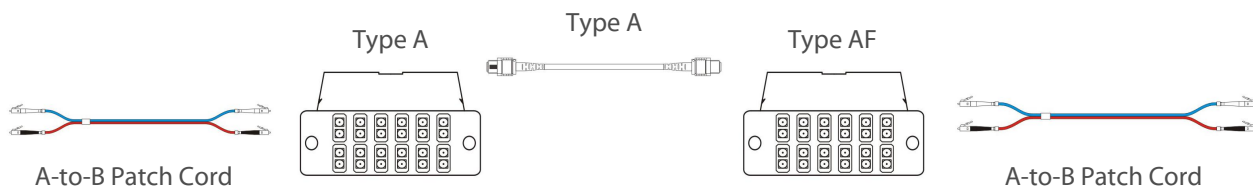
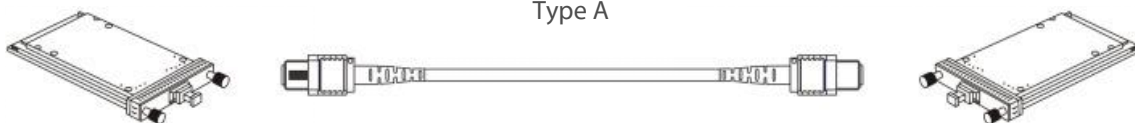



 <https://www.fs.com>



The information in this document is subject to change without notice. FS has made all efforts to ensure the accuracy of the information, but all information in this document does not constitute any kind of warranty.